



Development and performance evaluation of a novel knowledge guided artificial neural network (KGANN) model for exchange rate prediction



Pradyot Ranjan Jena ^{a,*}, Ritanjali Majhi ^b, Babita Majhi ^c

^a School of Management, National Institute of Technology Karnataka, Surathkal, Mangalore, India

^b School of Management, National Institute of Technology (NIT), Warangal, India

^c Dept. of Computer Science and Information Technology, Guru Ghasidas Vishwavidyalay, Central University, India

Received 6 October 2014; revised 20 November 2014; accepted 5 January 2015

Available online 10 September 2015

KEYWORDS

Artificial neural network;
Exchange rate forecasting;
Functional link artificial
neural network (FLANN);
Knowledge guided ANN
model

Abstract This paper presents a new adaptive forecasting model using a knowledge guided artificial neural network (KGANN) structure for efficient prediction of exchange rate. The new structure has two parallel systems. The first system is a least mean square (LMS) trained adaptive linear combiner, whereas the second system employs an adaptive FLANN model to supplement the knowledge base with an objective to improve its performance value. The output of a trained LMS model is added to an adaptive FLANN model to provide a more accurate exchange rate compared to that predicted by either a simple LMS or a FLANN model. This finding has been demonstrated through an exhausting computer simulation study and using real life data. Thus the proposed KGANN is an efficient forecasting model for exchange rate prediction.

© 2015 The Authors. Production and hosting by Elsevier B.V. on behalf of King Saud University. This is an open access article under the CC BY-NC-ND license (<http://creativecommons.org/licenses/by-nc-nd/4.0/>).

1. Introduction

Forecasting exchange rates is of prime importance for financial institutions as well as companies with exposure to foreign currencies. Corporate with such an exposure must necessarily

hedge their foreign currency cash flows in order to protect their profit from change in currency rates. However, hedging is costly and can be avoided if it will be possible to protect currency rate accurately. Hence developing such an efficient prediction based research methodology would be invaluable for Banks and Companies. To achieve this an objective attempt has been made by researchers to develop different models for prediction of various exchange rates. The initial models suggested in the literature are based on statistical methods (Brillinger, 1975; Hannan, 1979) which assume that the data are correlated and linear in nature. However, in practice it is observed that the financial time series, particularly the foreign exchange rates, do not satisfy such assumptions. As a result the prediction of exchange rates by the conventional statistical

* Corresponding author at: School of Management, National Institute of Technology Karnataka, Surathkal, Mangalore, India
E-mail address: jpradyot@gmail.com (P.R. Jena).

Peer review under responsibility of King Saud University.



Production and hosting by Elsevier

methods is not satisfactory. To improve the prediction capability the neural network based approach (Ziurilli, 1997) was suggested which is basically adaptive in nature and required training data constituting the past exchange rates to develop the models. Amongst the various neural networks, the multi-layer perceptron (MLP) (Haykin, 2004), the functional link artificial neural network (FLANN) (Pao, 1989), the cascaded functional link neural network (CFLANN) (Majhi et al., 2009) and the radial basis function (RBF) (Haykin, 2002) have been used for this purpose. In all these networks the learning algorithms that are used are mostly derivative based algorithms. In recent past evolutionary computing tools such as genetic algorithm (GA) (Bhattacharya and Meheta, 1998), genetic programming (GP) (Neely et al., 1997), particle swarm optimization (PSO) (Kennedy and Eberhart, 1995), bacterial foraging optimization (BFO) (Passino, 2002) have been also employed to train the weights associated with the architectures of different models. In Bansal et al. (2010), a framework for intelligent interaction of automatic trading algorithms with the user was presented. In Chang et al. (2009), a back propagation neural network was employed to predict the buy/sell points for a stock and then applied a case based dynamic window to further improve the forecast accuracy. In Atsalakis and Valavanis (2009), a survey of more than hundred articles which used neural networks and neuro-fuzzy models for predicting stock markets was presented. It was observed that soft computing techniques outperform conventional models in most cases. Defining the structure of the model is however, a major issue and is a matter of trial and error. In Venugopal Setty et al. (2010), review of data mining applications in stock markets was presented. Huang and Jane (2009) presented a hybrid model for stock market forecasting and portfolio selection. Simon and Raoot (2012) explored the possible research strategies in the accuracy driven ANN models. In Xu et al. (2008), trend following (TF) degrades in performance in proportion to the amount of fluctuation of the market trend. This finding is important to the design of technical trading systems. It implies that the fluctuation of market trend should be monitored; when it exceeds a certain threshold the TF trading should be paused to prevent loss. In Kumaran Kumar and Kailas (2012), the prediction of future stock close price of SENSEX and NSE stock exchange is found using the proposed hybrid ANN model of functional link fuzzy logic neural model. In Sheikhan and Movaghar (2009), a rich evolutionary connectionist model is proposed, in which GA is used to determine the optimum number of input and hidden nodes of a feedforward neural network, the optimum slope of nodes' activation function and the optimum values of learning rates and momentum coefficients. Empirical results on foreign exchange rate prediction indicate that the proposed hybrid model exhibits effectively improved accuracy, when compared with some other time series forecasting models. These new models have been reported to offer improved prediction performance particularly for high range of prediction. The drawback of evolutionary computing approaches is high computational time as these are population based algorithms.

In recent years many publications have appeared in the literature in the area of exchange rate forecasting. In Tsai and Wu (2000), the higher order fuzzy time series is used to forecast exchange rates. In another publication the authors (Minghui et al., 2003) have proposed a sequential learning, neural network named as minimal resource allocating network (MRAN)

to forecast various monthly exchange rates. They have shown that this model predicts exchange rates better than the MLP model. Kamruzzaman and Sarkar have recently applied (Kamruzzaman and Sarkar, 2003) three ANN models for predicting exchange rates using historical data and moving average technical indicators. The Kullback information criterion (KIC) has been tested (Seghouane and Bekara, 2004) on real data to forecast foreign currency exchange rate with interesting results compared to the classical techniques. The support vector machine (SVM) has also been proposed (Cao et al., 2005) for exchange rate prediction with promising results. Recently efficient prediction of various exchange rates has been suggested by us (Majhi et al., 2006, 2007, 2009) using a novel low complexity artificial neural network model. The authors have demonstrated that this new model is computationally simple but provides excellent exchange rate prediction performance.

These foreign exchange rate forecasting models are essentially adaptive in nature and are obtained by training them with known time series data and using some standard learning algorithms. Such type of models has limitations such as more training time and less accurate prediction capability particularly for high range. To improve the prediction performance such as less training time and better accuracy alternative models can be developed. Keeping this objective in view the present investigation has been made and a new knowledge guided ANN (KGANN) forecasting model for efficient prediction of various exchange rates has been proposed. A similar idea has already been applied by us in estimating the path loss in mobile communication (Panda et al., 2005). In the approach a crude model using an adaptive linear combiner (Widrow and Stearns, 2002) is first developed using past exchange rates as input. This approximate model serves as a knowledge guide to the overall model. To further improve the prediction performance a low complexity single layer FLANN structure (Pao, 1989) is added parallel to the linear combiner model. The weights of the FLANN model are trained using the same known input data and combining the outputs of the two structures. It is expected that the hybrid structure would provide superior prediction performance compared to the crude model alone. It may be noted that in the first phase the weights of the linear combiner are trained using standard least mean square (LMS) algorithm whereas in the second phase the weights of the FLANN are updated. During actual operation the KGANN functions as a fixed model and the FLANN is used as an adaptive model.

2. Development of knowledge guided ANN (KGANN) model

The KGANN hybrid adaptive model for the purpose of financial forecasting is shown in Fig. 1.

In the first stage an LMS model which is simple and robust is generated using a linear combiner and the LMS learning rule. To design this model, training patterns generated from exchange rate series are applied sequentially and for each pattern the output of the model is computed. This output is compared with the corresponding target value and the error is obtained. Using this error and the input the LMS algorithm computes the change in weights of the model. The training of the model continues with new input patterns until the squared error diminishes progressively and settles at a

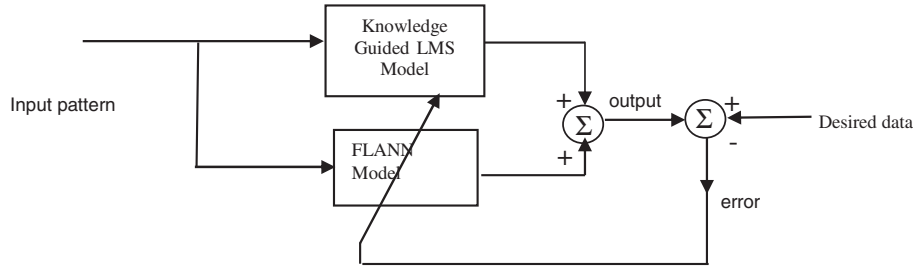

Figure 1 Knowledge guided ANN forecasting model.

minimum value. At this stage the final weights of the linear combiner are frozen. The model then represents a forecaster of the financial data. However its prediction performance can still be improved by using the knowledge guided LMS (KGL) model in one path of Fig. 1 and connecting a functional link artificial neural network (FLANN) based adaptive model in the other path. In this hybrid model the KGL acts as a fixed model whereas the FLANN updates its weights so that the resultant output of the two structures provides better prediction performance. The FLANN is essentially a single layer single neuron based structure with multiple nonlinear inputs. The nonlinear inputs are generated from a pattern of features expanding them using trigonometric or power series expansion. In the proposed method trigonometric expansions are used for achieving improved performance. The KGL provides most of the desired output and the differential value is supplied by the FLANN model. In the present case each input pattern consists of three values: the normalized conversion rate of a day, the mean and variance of eleven previous conversion values. Each of the three parameters is expanded to five values and all the fifteen values are weighted and summed to produce the output. For training the FLANN simple LMS algorithm is used.

The basic operation of the linear combiner proceeds as follows:

The general form of an adaptive linear combiner is shown in Fig. 2. In this case when the input pattern is applied the output of the combiner is represented as

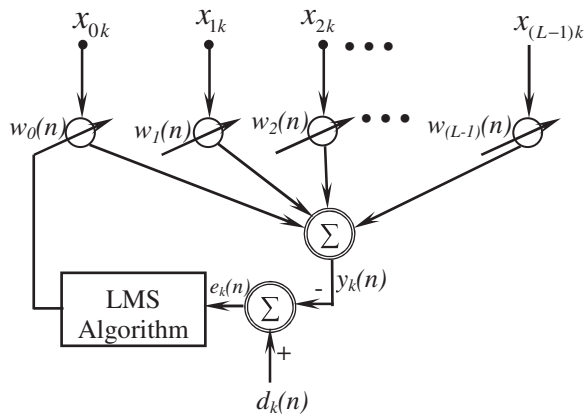

Figure 2 Adaptive linear combiner.

$$y_k(n) = \sum_{l=0}^{L-1} w_{lk}(n)x_{lk} \quad (1)$$

$$1 \leq k \leq K$$

$$0 \leq l \leq L-1$$

$$l \leq n \leq N$$

where x_{lk} , $w_{lk}(n)$ and $y_k(n)$ denote the l th input, l th weight and output due to k th pattern and n th experiment respectively.

If the weight and input pattern vectors are expressed as

$$X_k = [x_{0k} \ x_{1k} \ \dots \ x_{(L-1)k}]^T \quad (2)$$

$$W(n) = [w_0(n) \ w_1(n) \ \dots \ w_{(L-1)}(n)]^T \quad (3)$$

then in matrix form the output is given by

$$y_k(n) = X_k^T W(n) \quad (4)$$

The weights of the combiner are to be updated using LMS algorithm. Generally for the adaptive linear combiner the other data include a training signal, $d_k(n)$ which is the target exchange rate. This is accomplished by comparing the output with the desired response to obtain an error signal $e_k(n)$ and then adjusting or optimizing the weight vector to minimize this signal. The error signal is given by

$$e_k(n) = d_k(n) - y_k(n) \quad (5)$$

The weights associated with the network are then updated using the standard LMS algorithm. The weight update equation of l th weight at n th experiment is

$$w_l(n+1) = w_l(n) + \Delta w_l(n) \quad (6)$$

where $\Delta w_l(n)$ represents the average change of weights after all K patterns are applied and is computed as

$$\Delta w_l(n) = \frac{1}{K} \sum_{k=1}^K 2\eta e_k(n)x_{lk} \quad (7)$$

where η is the learning rate parameter ($0 \leq \eta \leq 1$). This procedure is repeated till the mean square error (MSE) of the network approaches a minimum value. The MSE at n th experiment may be defined as, $\xi = E[e_k^2(n)]$, where $E[\cdot]$ denotes the expectation operation.

A KGANN based forecasting model with FLANN as one of the structures is shown in Fig. 3.

Let P represent the number of input patterns out of which let K number of patterns be used for training and Q patterns are used for testing the performance of the proposed model. Hence $P = K + Q$. Let each input pattern consist of L feature elements and X represent the input training matrix of

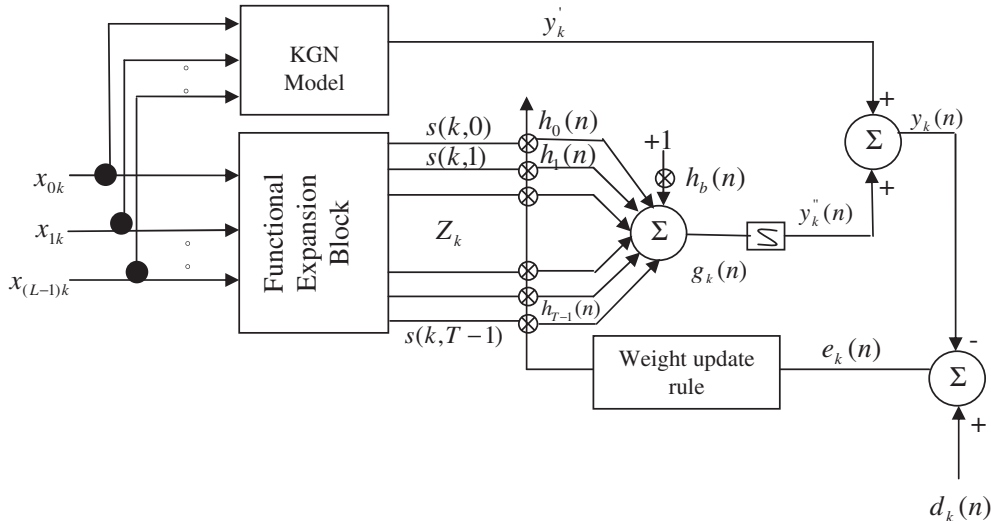

Figure 3 A KGANN based prediction model.

dimension $(K \times L)$. $v(k, l), 0 \leq k \leq K-1, 0 \leq l \leq L-1$ denotes an element of the matrix in which k and l stand for the input pattern number and feature number respectively. Each row of X is denoted as $V(k)$ which corresponds to the k th input pattern vector of L elements. Then each element of $V(k)$ is functionally expanded in a nonlinear manner using sine and cosine expansions. Such transformation maps the input elements nonlinearly and involves simple computations. The elements $s(k, t)$ of the expanded input vector correspond to k th pattern generated from $V(k)$ as shown in (8).

$$\begin{aligned} s(k, l(2m+1)) &= v(k, l) \\ s\{k, (2m-1)\} &= \sin\{(2m-1)\pi \cdot v(k, l)\} \\ s(k, 2m) &= \cos\{(m-1)\pi \cdot v(k, l)\} \end{aligned} \quad (8)$$

$m = 1, 2, \dots, M$ and $l = 0, 1, \dots, (L-1)$

The symbol M represents number of sine or cosine expansions. As a result the X feature matrix of size $(K \times L)$ after nonlinear transformation generates the \underline{S} matrix of size $(K \times T)$, where $T = L(2M+1)$. For convenience let each row of S be denoted as Z_k , which is of size $(T \times 1)$, where

$$Z_k(n) = [s(k, 0), s(k, 1), s(k, 2) \dots, s(k, T-1)]^T \quad (9)$$

Thus Z_k , the transformed feature vector corresponding to k th pattern, consists of T elements and is used as input to a single neuron neural network. This adaptive network is essentially an adaptive linear combiner followed by a single neuron as shown in Fig. 3. The weights $h_0(n), h_1(n), h_2(n), \dots, h_{T-1}(n)$ represent the elements of a weight vector $H(n)$ at n th experiment. During training process, each expanded input pattern Z_k is applied to the model sequentially and the desired financial value is supplied at the output. At any n th experiment given the input, the model produces an output $y_k(n)$ which acts as an estimate of the desired value, $d_k(n)$. The output of the combined model is computed as

$$y_k(n) = y'_k + y''_k(n) = X_k^T W + \{Z_k^T H(n) + h_b(n)y\} \quad (10)$$

where $h_b(n)$ represents the weighted bias input which depends on the input pattern and whose weight corresponds to the optimized weights trained in the first phase. The nonlinear function

$f\{\cdot\}$ is a two sided sigmoidal function. y'_k is the output of KGN model. The output $y''_k(n)$ of the FLANN model is given by

$$y''_k(n) = f\{g_k(n)\} = \frac{1 - e^{-g_k(n)}}{1 + e^{-g_k(n)}} \quad (11)$$

The error signal $e_k(n)$ is the difference between the desired response and the model output and is given by

$$e_k(n) = d_k(n) - y_k(n) \quad (12)$$

The error term $e_k(n)$ and the input vector Z_k are employed to the weight update algorithm to compute the correction weight vector $\Delta h(n)$. Let the reflected error is given by

$$\delta_k(n) = e_k(n) \cdot d'_k(n) = e_k(n) \cdot f'\{g_k(n)\} \quad (13)$$

where $f'\{\cdot\}$ represents the derivative of $y''_k(n)$. Then the correction weight vector is given by

$$\Delta h_k(n) = \eta Z_k \delta_k(n) \quad (14)$$

In the same way the change in bias weight can be obtained and is given by $\Delta h_{bk}(n) = \eta \delta_k(n)$. A new known feature pattern is applied at the input and its corresponding $\Delta h(n)$ is computed. The learning coefficient, η controls the convergence rate and lies between 0 and 1. This procedure is repeated until all the test patterns are applied. Application of all the K patterns constitutes one experiment and at the end of each experiment K sets of $\Delta h_k(n)$ are obtained. Then the average change of weight of the t th weight in the n th experiment is computed as

$$\Delta h_t(n) = \frac{1}{K} \sum_{k=1}^K \Delta h_{tk}(n) \quad (15)$$

where $\Delta h_{tk}(n)$ represents the change in t th weight at k th input pattern of n th experiment.

The weights of the FLANN model is then updated according to the relation

$$H(n+1) = H(n) + \Delta H(n) \quad (16)$$

$$\text{where } \Delta H(n) = [\Delta h_0(n) \quad \Delta h_1(n) \quad \dots \quad \Delta h_{T-1}(n)]^T \quad (17)$$

Similarly the bias weight for the n th iteration is given by

$$\Delta h_b(n) = \frac{1}{K} \sum_{k=1}^K \Delta h_{bk}(n) \quad (18)$$

Table 1 Exchange rates available for training and testing.

Currency conversion	Date range	Total nos. of data available	Total nos. of patterns generated	No. of patterns used for training	No. of patterns used for testing
1US\$ to Indian Rupees	73-01-01 to 05-10-01	393	382	365	17
1US\$ to British Pound	71-01-01 to 05-10-01	418	407	390	17

Note: The data show the average of daily figures (noon buying rates in New York City) on the 1st day of each month. The data have been taken from www.forecasts.org.

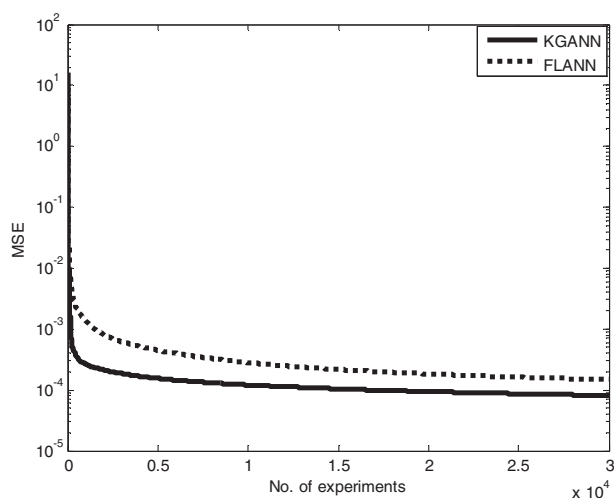

Figure 4a Comparison of convergence characteristics of knowledge base and FLANN models of Rupees conversion for one month ahead of prediction.

The bias weight is then updated according to

$$h_b(n+1) = h_b(n) + \Delta h_b(n) \quad (19)$$

Experiments are then continued until the mean square error (MSE) in the n th experiment defined as

$$\text{MSE}(n) = \frac{1}{K} \sum_{k=1}^M e_k^2(n) \quad (20)$$

attains a minimum value. When the training process is complete, the connecting weights of the model are frozen to their final values. The model so developed is then used for testing with known exchange rates and for future prediction.

The KGANN model developed is a nonlinear adaptive model and has the ability to approximate a known financial time series through a supervised training. It is an elegant simple nonlinear model for prediction of future financial data. The algorithm used in the FLANN is an optimum method for computing the gradients of the error performance surface obtained from the single layer FLANN with regard to adjustable weights. Like the LMS algorithm the proposed algorithm is robust with respect to disturbance or noisy data. The algorithm also provides a promising model for extracting information contained in the training data and storing in the weights of the FLANN model. The simulation of the proposed model using known exchange rates is carried out based on the FLANN algorithm and its performance is evaluated using test data. Subsequently the prediction of the future financial data is

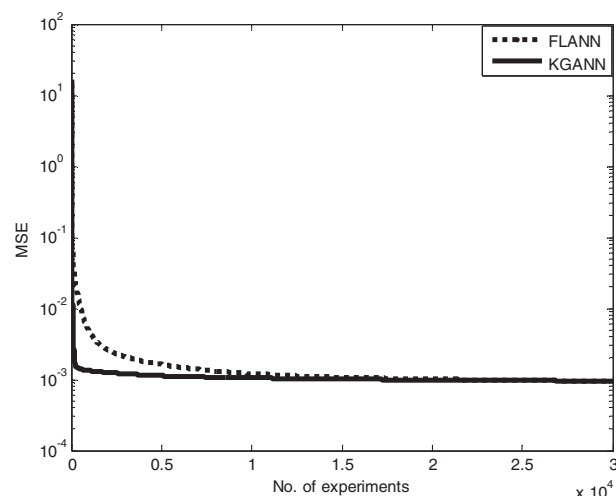

Figure 4b Comparison of convergence characteristics of knowledge base and FLANN models of Rupees conversion for twelve months ahead of prediction.

carried out employing the past data as input to the proposed model.

3. Design of input data

The present work introduces the KGANN model to predict the conversion rates from 1US\$ to Pound and Rupees. Some common features from past conversion rates are extracted for training and testing purposes. Each set of data is normalized by dividing each value by the maximum value of each set such that each normalized value is less than or equal to unity. Normalization of input data is necessary for obtaining correct trigonometric expansion. The normalized rate on the first day of a month, the mean and variance values computed up to the present month are considered as the inputs to model. To obtain the mean and variance values of a given month twelve conversation rates (present one and eleven preceding values) are used. Table 1 shows the number of input patterns used for training and testing purposes of all the conversion rates.

4. Simulation study

To evaluate the performance of the proposed model the simulation study of KGANN, FLANN and LMS models is carried out to predict conversion rates of US\$ to Indian Rupees and

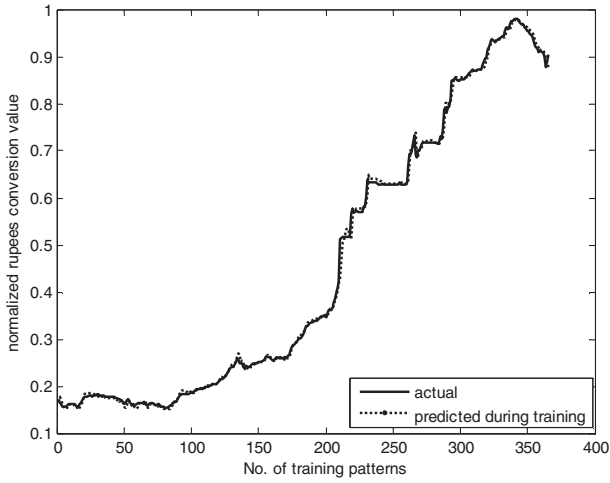

Figure 4c Comparison of actual and predicted value using training data of Rupees conversion for one month ahead of prediction.

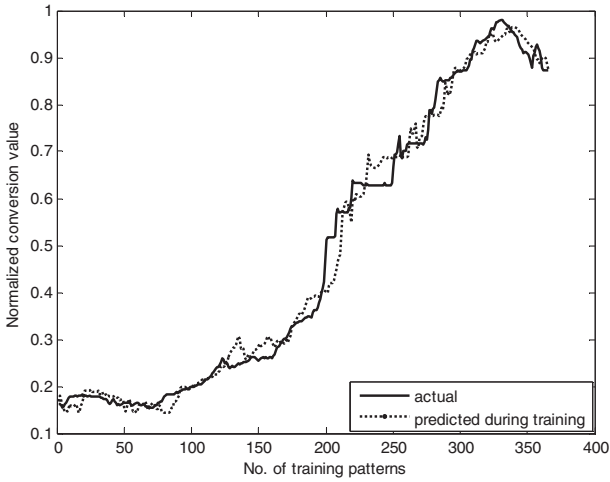

Figure 4d Comparison of actual and predicted value using training data conversion for twelve months ahead of prediction.

British Pounds. The prediction durations are one month, three months, six months and twelve months ahead. The learning characteristics of the proposed model is shown in Figs. 4a and 4b for Rupees exchange rate whereas the same for Pound conversion is shown in Figs. 5a and 5b. At first the LMS model is trained using the past features and subsequently the FLANN model is trained using the combined output of the KGANN model. The comparison of actual and predicted values using training data for Rupees is displayed in Figs. 4c and 4d, whereas the same for Pound is shown in Figs. 5c and 5d. The convergence characteristics show superior performance in all cases particularly in terms of minimum MSE and rate of convergence. This observation is more evident from the plots of Figs. 4c, 4d, 5c and 5d.

The results using test data are shown in Table 2. It compares the average percentage of error associated with predicted values of three different models. The mean average percentage of error $MAPE(k)$ is defined as

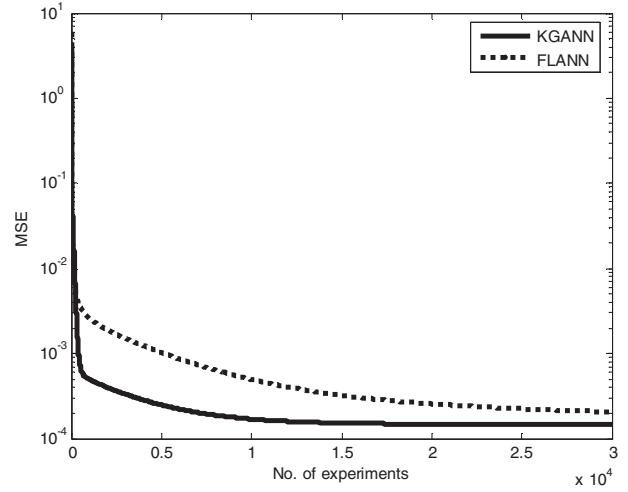

Figure 5a Comparison of convergence characteristics of knowledge base and FLANN models of Pound conversion for one month ahead of prediction.

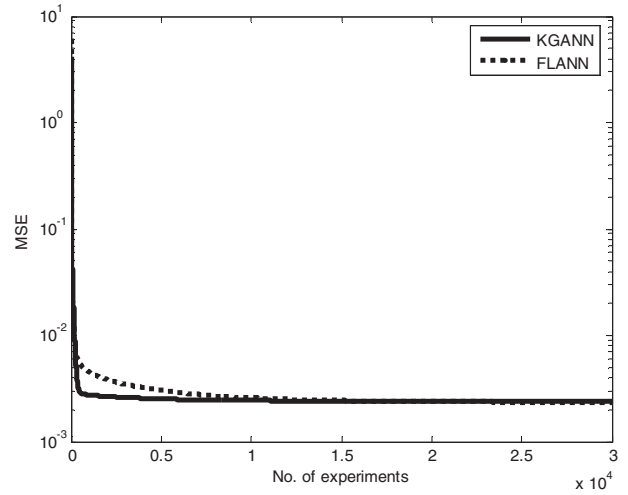

Figure 5b Comparison of convergence characteristics of knowledge base and FLANN models of Pound conversion for twelve months ahead of prediction.

$$MAPE(k) = \frac{\sum_{m=1}^M PE(m)}{M} \tag{21}$$

where k represents the number of months ahead prediction is made. $PE(m) = (acr(m) - pcr(m)/acr(m)) \times 100\%$, $acr(m)$ = actual conversion rate of m th month, $pcr(m)$ = predicted conversion rate of m th month, $PE(m)$ = the percentage of error corresponding to m th month.

The results indicate that in all cases the proposed KGANN model provides the best prediction of foreign currency rates compared to other two methods. This observation is true for all currency conversions and for all future months ahead. Table 3 shows the actual and predicted exchange rates (US\$ to Rupees and US\$ to Pound) for one and twelve months ahead. Table 3 clearly shows close prediction of exchange rates by KGANN model.

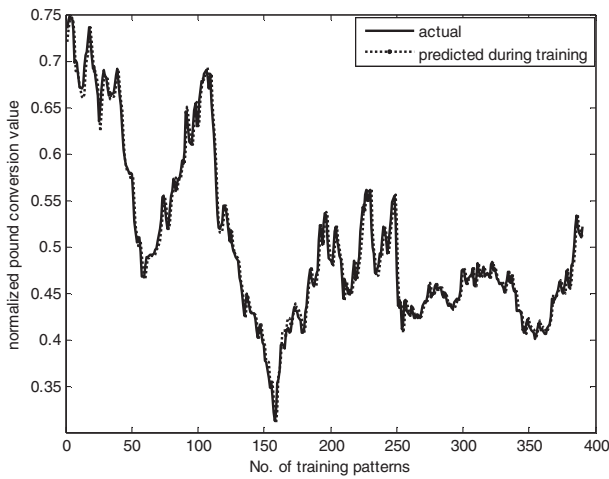

Figure 5c Comparison of actual and predicted value using training data of Pound conversion for one month ahead of prediction.

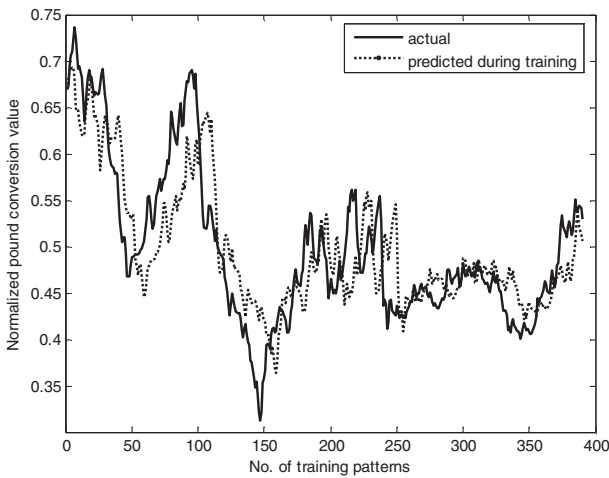

Figure 5d Comparison of actual and predicted value using training data of Pound conversion for twelve months ahead of prediction.

Table 2 Comparison of MAPE obtained from simulation study of three different models.

Exchange rate	Months' ahead	LMS	FLANN	KGANN
Rupees	1	1.1697	0.7966	0.7870
	3	3.2902	1.9785	1.9409
	6	4.8545	3.7054	3.0895
	12	7.0189	6.2092	4.9019
Pound	1	2.1886	1.8434	1.8466
	3	5.0808	2.8010	2.7827
	6	6.7061	4.5978	3.7659
	12	11.2544	2.1349	2.1896

The bold values signify that the MAPE values obtained by KGANN method is the least compared to the other two methods such as LMS and FLANN for all the rows.

Table 3 Comparison of actual and predicated exchange rates using KGANN model.

Exchange rate	Month's ahead	Actual value	Predicted value	
Rupees	One	45.1800	43.8539	
		45.5000	45.1788	
		46.0600	45.4751	
		46.3200	46.0300	
		46.0500	46.2958	
		45.7400	46.0354	
		45.0300	45.7287	
		43.8500	45.0090	
		43.6200	43.8000	
		43.5800	43.5844	
		43.5900	43.5626	
		43.6400	43.5863	
	43.4100	43.6433		
	43.5200	43.4004		
	43.4300	43.5280		
	43.5500	43.4398		
	43.8500	43.5627		
	Twelve	43.6400	43.7848	
		43.4100	45.6560	
		43.5200	46.2308	
43.4300		46.9453		
43.5500		47.2052		
43.8500		46.8484		
Pound		One	1.8279	1.7867
			1.8438	1.8300
	1.8203		1.8458	
	1.7937		1.8203	
	1.8077		1.7918	
	1.8607		1.8059	
	1.9286		1.8609	
	1.8797		1.9320	
	1.8871		1.8799	
	1.9043		1.8876	
	1.8961		1.9054	
	1.8559		1.8963	
1.8177	1.8535			
1.7507	1.8134			
1.7944	1.7438			
1.8064	1.7895			
1.7651	1.8020			
Twelve	1.8559	1.7694		
	1.8177	1.8090		
	1.7507	1.8184		
	1.7944	1.7842		
	1.8064	1.7485		
	1.7651	1.7588		

5. Conclusion

The existing studies based on ANN models to predict exchange rate have relied mostly upon the LMS or the FLANN models for the prediction. The present work has proposed a hybrid model of foreign currency rate prediction by combining both the LMS and the FLANN model together that provides more accuracy and efficiency in prediction than either the LMS or the FLANN individually.

Initially the simple and low complexity LMS model is trained using known exchange rate data. After completing

the training process the final weights of the combiner are frozen. Subsequently the input patterns are applied to the combined systems and the target currency value is compared with the combined output. The resulting error signal is used to update the parameters of the FLANN model so that the overall system error is further reduced. The prediction performance of the proposed model is compared with that obtained by individual FLANN and LMS based models meant for various currency conversion rates and for various range of prediction. Comparison of the simulation results reveals that the proposed hybrid model is capable of making more accurate prediction of various exchange rates compared to those predicted by individual FLANN and LMS based models.

The proposed hybrid model may be employed for long range prediction of exchange rates as the fixed model performs the basic prediction whereas the second adaptive model attempts to predict the difference between the actual and the true value. Further, future work can also be carried out in choosing the right combination of the fixed and adaptive models. In addition appropriate weightage of both the outputs needs to be evaluated so that the final output would be close to the desired exchange rate.

References

- Atsalakis, G.S., Valavanis, K.P., 2009. Surveying stock market forecasting techniques – part II: soft computing methods. *Expert Syst. Appl.* 36, 5932–5941.
- Bansal, Archit, Mishra, Kaushik, Pachouri, Anshul, 2010. Algorithmic trading (AT) – framework for futuristic intelligent human interaction with small investors. *Int. J. Comput. Appl.* 1 (21), 01–05.
- Bhattacharya, S., Meheta, K., April 1998. Staged learning of trading rules using genetic algorithm. In: Proc. of 3rd INFORMS, Conf. on Info. Sys. and Tech. Montreal, pp. 62–66.
- Brillinger, D.R., 1975. *Time Series Analysis: Forecasting and Control*. Hoff, Rinehart and Winston Inc., NY.
- Cao, Ding-Zhou, Pang, Su-Lin, Bai, Yuan-Huai, 18–21 August 2005. Forecasting exchange rate using support vector machines. In: IEEE 4th Int. Conf on Machine Learning and Cybernetic, Guanghou, pp. 3448–3452.
- Chang, P.-C., Liu, C.-H., Lin, J.-L., Fan, C.-Y., Ng, Celeste S.P., 2009. A neural network with a case based dynamic window for stock trading prediction. *Expert Syst. Appl.* 36, 6889–6898.
- Hannan, E.J., 1979. *Multiple Time Series*. John Wiley and Sons Inc., NY.
- Haykin, S., 2002. *Adaptive Filter Theory*. Prentice-Hall International Edition, India.
- Haykin, S., 2004. *Neural Networks*. Pearson Edition.
- Huang, K.Y., Jane, C.-J., 2009. A hybrid model for stock market forecasting and portfolio selection based on ARX, grey system and RS theories. *Expert Syst. Appl.* 36, 5387–5392.
- Kamruzzaman, Joarder, Sarkar, Ruhul A., December 2003 14–17. Forecasting of currency exchange rates using ANN: a case study. In: IEEE Int. Conf. Neural Networks Signal Processing, Nanjing, China, pp. 793–797.
- Kennedy, J., Eberhart, R., Dec 1995. Particle swarm optimization. In: Proc. IEEE Int. Conf. Neural Networks, Perth, Australia, pp. 1942–1948.
- Kumaran Kumar, J., Kailas, A., 2012. Prediction of future stock close price using proposed hybrid ANN model of functional link fuzzy logic neural model (FLFNM). *Int. J. Comput. Appl. Eng. Sci.* II (1).
- Majhi, Ritanjali, Panda, G., Sahoo, G., 7th–9th June 2006. Efficient prediction of foreign exchange rate using nonlinear single layer artificial neural model. In: Proc. of IEEE International Conference on Cybernetics & Intelligent Systems (CIS) and Robotics Automation & Mechatronics (RAM) (CIS & RAM-2006), Bangkok, pp. 1–5.
- Majhi, Ritanjali, Panda, G., Sahoo, G., 23rd–25th February 2007. Development of an efficient cascaded functional link artificial neural network model for exchange rate forecasting. In: Proc. of International Conference on Intelligent Systems and Networks (IISN-2007), Jagdhari, Haryana, pp. 242–246.
- Majhi, Ritanjali, Panda, G., Sahoo, G., 2009. Efficient prediction of exchange rates using low complexity artificial neural network models. *Expert Syst. Appl.* 36 (1), 181–189, Elsevier Journal, UK.
- Minghui, Hu, Saratchandra, P., Sundararajan, Narasimhan, 2003. A sequential learning neural network for foreign exchange rate forecasting. *IEEE*, 3963–3968.
- Neely, C. et al, 1997. Is technical analysis in the foreign exchange market profitable: a genetic programming approach. *J. Financ. Quant. Anal.* 32 (4), 2.
- Panda, G., Mishra, R.K., Pallai, S.S., 2005. A novel site adaptive propagation model. *IEEE Trans. Antennas Wirel. Propag. Lett.* 4, 447–448.
- Pao, Y.H., 1989. *Adaptive Pattern Recognition and Neural Network*. Addison–Wesley Publishing Company, Int..
- Passino, K.M., 2002. Biomimicry of bacterial foraging for distributed optimization and control. *IEEE Control Syst. Mag.*, 52–66.
- Seghouane, Abd-Krim, Bekara, Maiza, 2004. A small model selection criterion based on Kullback’s symmetric divergence. *IEEE Trans. Signal Process.* 52 (12), 3314–3323.
- Sheikhan, Mansour, Movaghar, Behzad, 2009. Exchange rate prediction using an evolutionary connectionist model. *World Appl. Sci. J.* 7, 08–16 (Special Issue of Computer & IT): ISSN 1818–4952, © IDOSI Publications.
- Simon, Selvan, Raoot, Arun, 2012. Accuracy driven artificial neural networks in stock market prediction. *Int. J. Comput. Appl.* 1 (3), 33–43, *International Journal on Soft Computing (IJSC)*, vol. 3(2), May 2012.
- Tsai, Chao Chih, Wu, Shun Jyh, 2000. Forecasting exchange rates with fuzzy logic and approximate reasoning. *IEEE*, 191–195.
- Venugopal Setty, D., Rangaswamy, T.M., Subramanya, K.N., 2010. A review on data mining applications to the performance of stock marketing. *Int. J. Comput. Appl.* 1 (3), 33–43.
- Widrow, B., Stearns, S.D., 2002. *Adaptive Signal Processing*. Pearson Education.
- Xu, S., Li, B., Shao, Y., December 2008, Neural network approach based on agent to predict stock performance. In: IEEE International Conference on Computer Science and Software Engineering, vol. 1, Wuhan, China, pp. 1223–1225.
- Ziurilli, J.S., 1997. *Financial Prediction using Neural Networks*. International Thompson Computer Press, London.